

MANISCOPIC

MHT 860 L
Turbo



- Capacity : 6000 kg
- Lift height : 8,10 m
- Engine : 132 cv
- 4 wheel steer – 4 wheel drive
- Hydrostatic transmission
- Frame levelling 10°/10°

 **MANITOU**

MHT 860 L TURBO LSU

LOAD CENTRE AT 600 MM

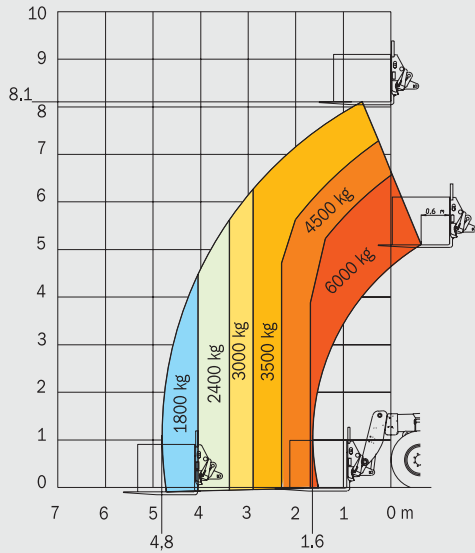

LOAD CENTRE AT 900 MM

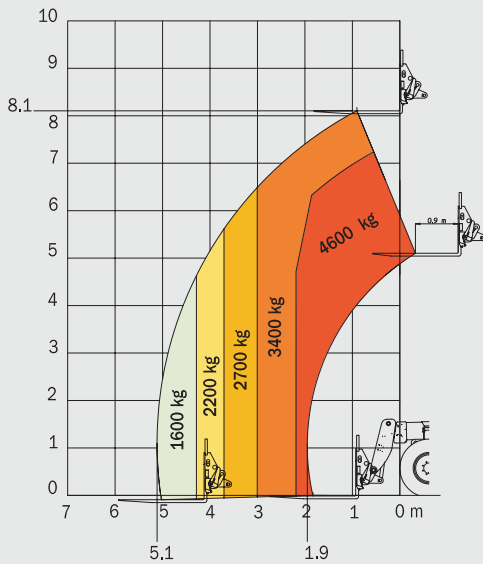

LOAD CENTRE AT 1200 MM

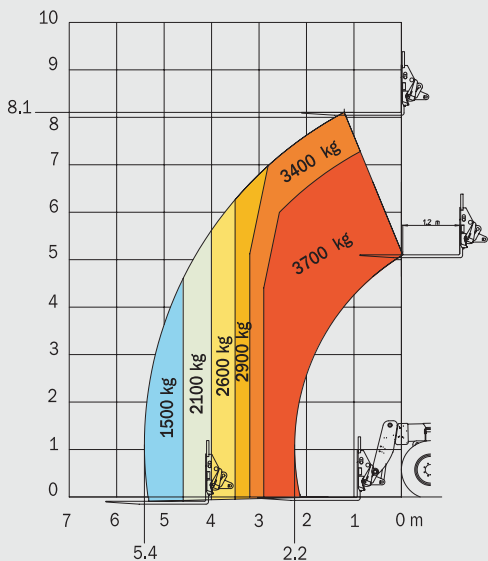

ENGINE

Diesel PERKINS 1104C-44 TA

Capacity :

4 cylinders/4400 cm³

Power (ISO/TR 14396):

132 HP/97 kw

Rated speed

2200 r.p.m.

Maximum torque at 1400 r.p.m. :

500 Nm

Injection directe

Fan :

puller

Cooling :

water

Anti-polluting standards :

EUR2

Battery :

12 Volts

Capacity :

120 Ah

LIFT CAPACITY / HEIGHT

Load centre at 600 mm at 900 mm at 1200 mm

Lift capacity : 6000 kg 4600 kg 3700 kg

Capacity at max. height : 3500 kg 3400 kg 3400 kg

Capacity at max. front reach : 1800 kg 1600 kg 1500 kg

Lift height : 8,10 m 8,10 m 8,10 m

Maximum front reach : 4,80 m 5,10 m 5,40 m

TRANSMISSION

Hydrostatic transmission

Hydrostatic pump with variable flow and continuous speed regulation

Reversing shift :

electro-magnetic

2 forward and reverse speeds :

Low speed :

10 km/h

Fast speed :

32 km/h

HYDRAULICS

Main pump : Piston Load Sensing Haute pression

Maximum pressure :

275 bar

Capacity :

140 L/mn

Steering pump

Type :

Load Sensing

Maximum pressure :

170 bar

Drive Type : Proportional hydraulic joystick with 3 simultaneous movements

- 1- Lifting
- 2- Crowed
- 3- Boom extension
- 4- Auxiliary

AXLES

HURTH "Heavy Duty", oil bath with epicycloidal reduction with 4 satellites Integrated steering cylinders with double action in high position

Frame levelling 10°/10° on front axle

3 steering modes:

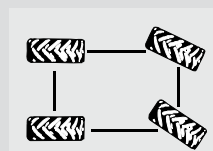

2 wheel steering

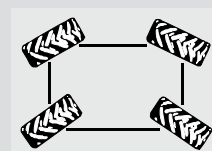

4 wheel steering

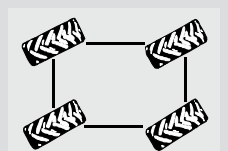

Crabsteer

DIAGRAMS

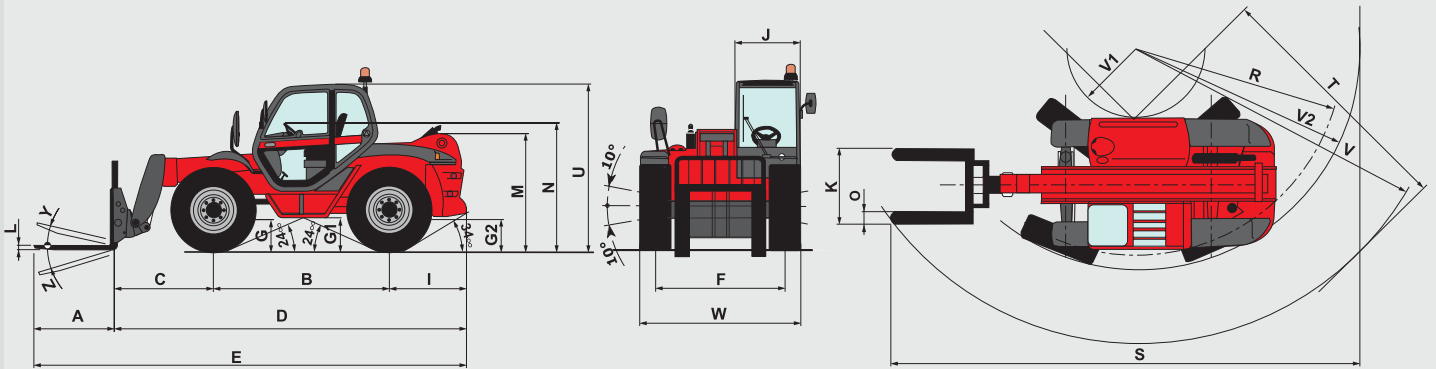

A	B	C	D	E	F	G	G1	G2	I	J	K	L	M	N	O	R	S	T	U	V	V1	V2	W	Y	Z
1200	2730	1540	5365	6565	1930	465	500	465	1095	865	1750	60	1725	1845	200	3550	7950	4050	2450	4850	1130	3750	2400	11°	125°

BRAKES

Type : oil bath multidisc
 Drive type : hydraulic
 On axle : front + rear
 Parking brake on front axles :
 Oil bath multidisc negative parking brake.

CAPACITIES

Cooling circuit : 15 L
 Engine oil : 8,1 L
 Equipment hydraulic oil : 140 L
 Fuel tank : 120 L

TYRES

Model : 18 - 22,5 16 PR
 Pressure : 5 bar
 Drawbar pull : 11200 daN

STANDARD EQUIPMENTS

- ROPS-FOPS cabin
- GRAMMER seat
- Front and rear wipers
- Driving lights
- Rotating beacon
- Left rearview mirror
- Safety device with automatic lock of aggravating movements
- Safety valves on cylinders
- Heating

LIFTING/TELESCOPING MOTIONS

Unladen lifting : 9.8 sec
 Unladen lowering : 7.8 sec
 Unladen extending internal telescope : 11.3 sec
 Unladen retracting internal telescope : 6.7 sec

FORKS

Dimensions : 200 x 60 x 1200 mm
 Weight of forks carriage : 560 kg

OPTIONS

- Air conditioning
- Comfort seat
- Roof wipers
- Cabin rearview mirror
- Tyres 445/70 R24

WEIGHT

Total weight with equipment : 11515 kg
 Total weight laden with forks : 17515 kg

MHT 860 L TURBO LSU

Manitou, material handling world leader

Inventor of the rough terrain forklift truck, Manitou offers today the most comprehensive range to meet all specific handling and personal lifting requirements :



Telescopic trucks

MANISCOPIC

Rough terrain and semi industrial masted trucks

MANITOU



Access equipment

MANIACCESS

Compact telescopic handler

Twisco



Truck mounted forklifts

MANITRANSIT

Backhoe/Loader with telescopic boom

MANIHOE

Swinging arm and articulated wheeled loaders

MANILOADER

Electric pallet trucks and electric stackers

MANILEC



A network of skilled professionals at your service

With a network of 500 service and parts centres in more than 100 countries, Manitou provides an efficient after-sales support based on the expertise of 2000 factory trained technicians.



This publication in no way constitutes an offer and the company reserves the right to alter specification without prior notice. The MANITOU models presented in this brochure can be supplied complete with optional equipment attachments.

MANITOU BF SA

B.P. 249 - 44158 Ancenis Cedex - France
Tél. : 33 2 40 09 10 11 / Export Department Fax : 33 2 40 09 10 97
www.manitou.com

700301EN 09/06



MANITOU